

FOR MORE THAN 35 YEARS
WE'VE BEEN FINDING BETTER WAYS
TO COMPRESS AIR & GAS

HIGH PRESSURE

HIGH QUALITY

HIGH AIR



High Air Machinery Co.,Ltd

📍 No.155, Tinghua RD,
Shanghai, PRC 201505

☎ Phone:86-21-60892089

📠 Fax:86-21-60892120

✉ sale@highair.co

🌐 Web: <http://www.highair.co>



ISO 9001:2000 Certificated

YB-HG-001-2015

COPY RIGHT 2015 HIGH-AIR MACHINERY CO.

*PERFORMING
UNDER PRESSURE*

High Air Machinery
HG SERIES
COMPRESSOR
Air/Nitrogen/Helium/Natural Gas

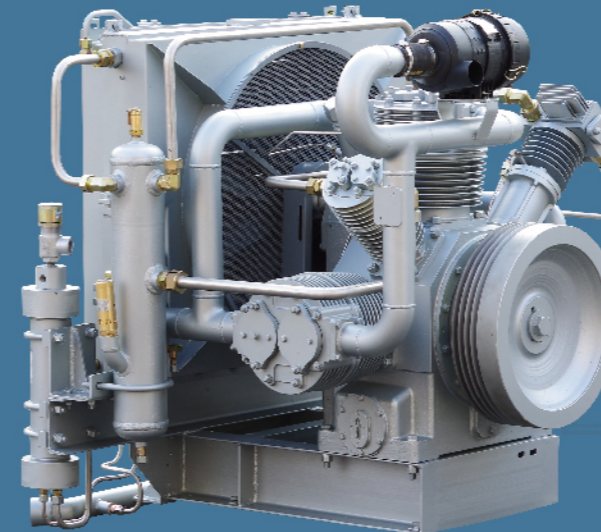

UP TO 50 MPa
10M³/min



[Overview Product Range]

Our high-pressure compressors and compression system, which compress air, nitrogen, natural gas and other noble gases, are manufactured with the international standard in following very strict design & quality guidelines.

For more than 35 years, HIGH AIR has been the very professional supplier, we HIGH AIR has always provided the engineering design, manufacture, and on-site testing for the field of high pressure gas compression, providing turkey-solutions for customers.

A full range of product lines, working pressure up to 50MPa and flow rate from 0.1M3/MIN to 10M3/MIN, to meet the diversified requirements.

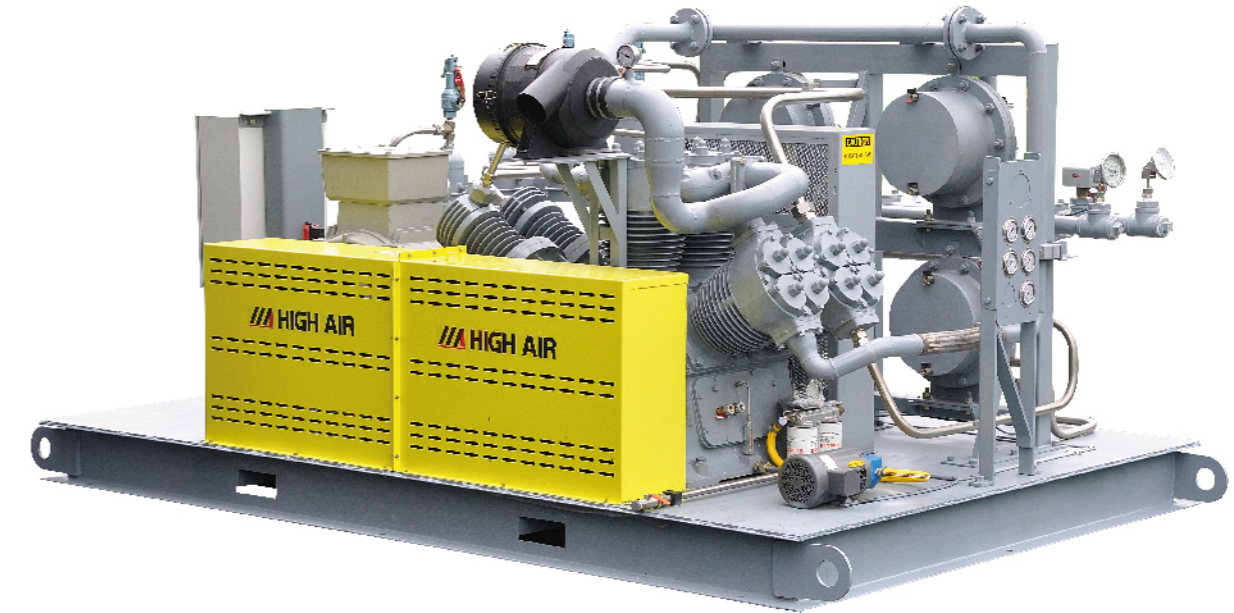
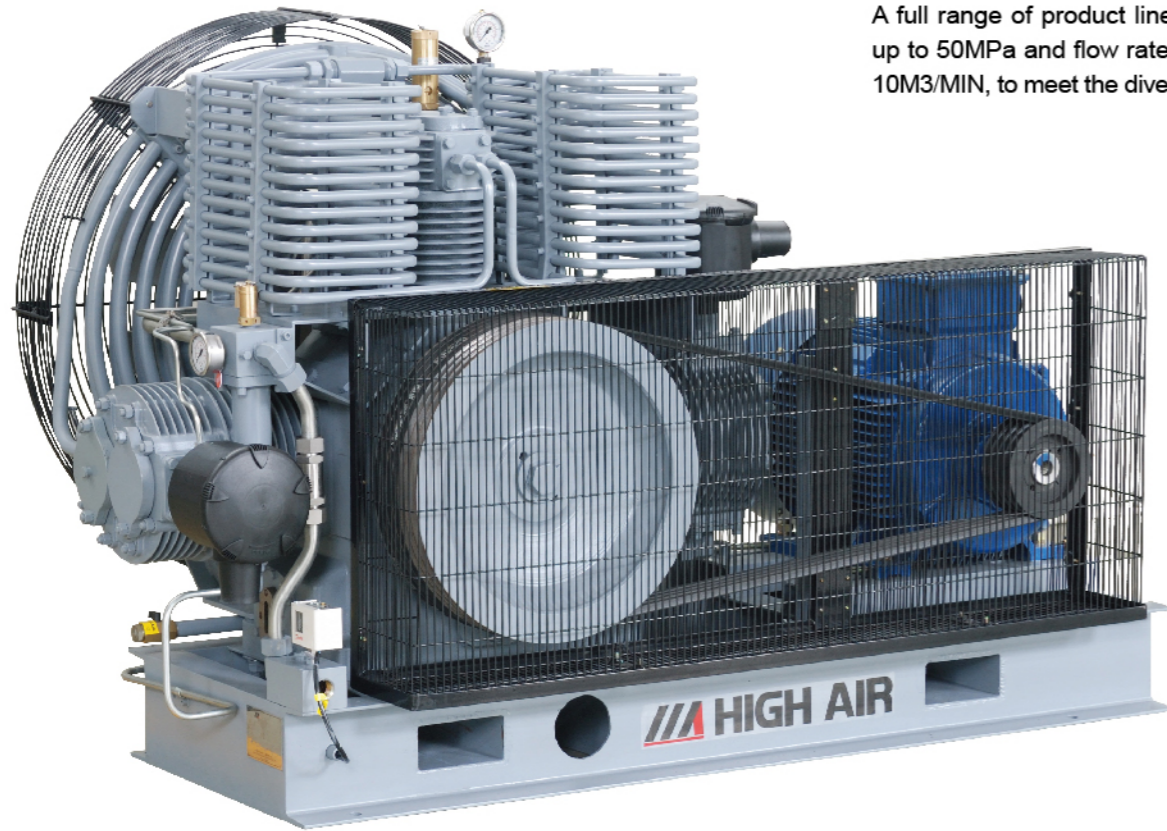

[Field of Application]

Oil Field/ Gas Applications

- > Seismic exploration
- > Pipeline testing
- > Well servicing
- > Gas gathering
- > Flare gas/gas injection
- > Petrochemical
- > Refining
- > Chemical Industry
- > Fuel boosting
- > Offshore

PET

- > Bottle blowing

Industrial Applications

- > Hydropower station
- > Defense industry
- > High pressure testing
- > Wind tunnel
- > High pressure tank testing
- > Helium Cylinder Filling
- > Helium Balloon Gas Recovery

[Advantages]

- > With technology and economy in mind, the unique module design from HIGH AIR always provides the optimal solutions for customers.
- > High quality material and components ensures efficient and reliable operation, even in harsh environments/applications.

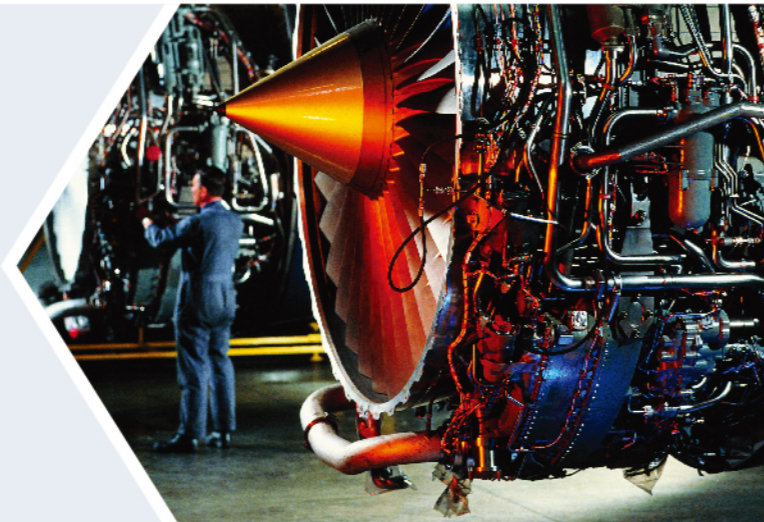

- > Regarding to the compressor and the whole system, we offer a wider range of products and services, provide customers with a turkey-solution.
- > The varied types of models meet various applications
- > Designed for continuous operation
- > Air/water cooling

[Technical Features]

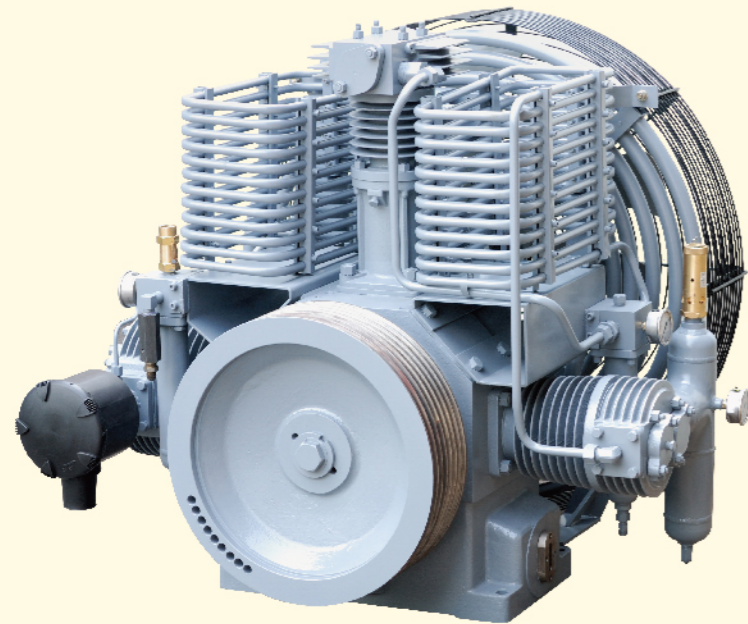

Design Features/Cooling

High-efficiency cooling system, low discharge temperature

Air/water coolers optional

Integrate Coolers cooled by independent cooling fan

Separators and condensate drain after each stages

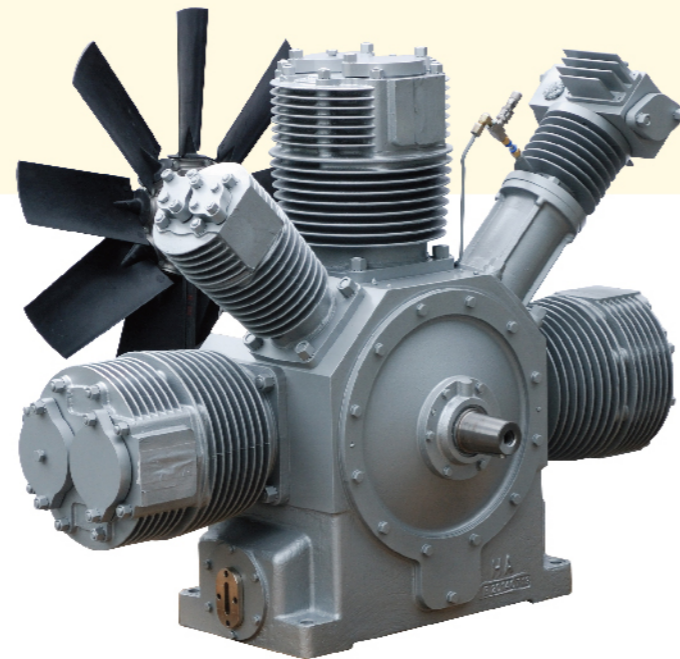

Design Features/Lubrication

Forced feed lubrication by a gear oil pump,
For reliable lubrication and air cooling.

Monitor the lubrication system
pressure,ensure the completed unit
lubricating

Ultrafilters for component protection
Continuous monitoring of lubrication
system

Technical Advantages

We provide not only the standard control
system,but the custom-made system base on
requirements from clients.

As robust design,our compressors can work
efficiently and steadily in different conditions of
continuous running or intermitant operation.

Design Features/Compressor blocks

The air-cooled compressor blocks,especially designed for the harsh environment of high
pressure gas. Multi-stages to reduce the loading between each stage. Single-action
cylinders with deep fins for high reliability.

High quality valves designed for specific applications

Overload-type filters imported with original packaging to clear the system,tailored for
special applications

Compressor block mounted on the skid. No foundation required

Crosshead and Steeple Piston in high pressure stage

Roller bearings on crankshaft,needle bearings in pistons and shell
bearings on connection rods

Driven by standard section "V" belts

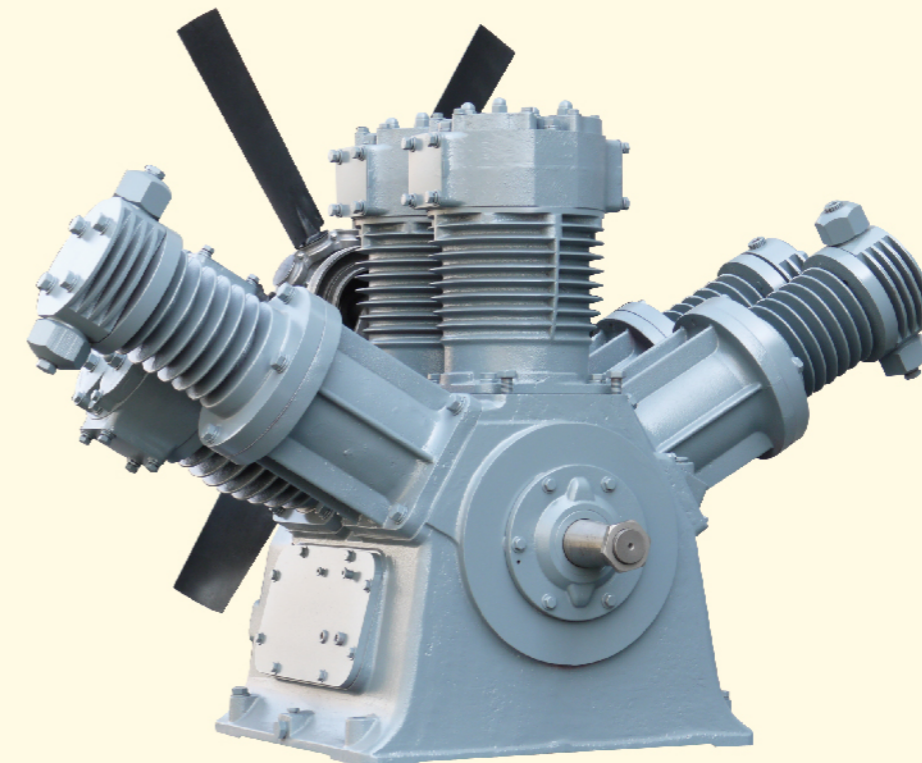

High Pressure HG Series Compressors



[ADVANTAGES]

If your productivity depends on high pressure air or gas, HIGH AIR Compressors have a solution. Provide us with your job specifications and we will design a high pressure package customized to your needs. Our patented design offers size, cost and weight advantages over other packages.



Marine seawater cooled high pressure compressor

[TURNKEY PACKAGING]

- > Diesel engine/gas engine driven
- > High pressure air compressors truck/trailor mounted
- > High pressure breathing air compressors
- > Multiple combined system
- > Air boosters
- > Helium recovery compressors
- > Natural gas compressors
- > Specialized units per customers' requirements



Compounded System
High Pressure Compressor with Dryer and Frame

[SPECIFICATIONS]

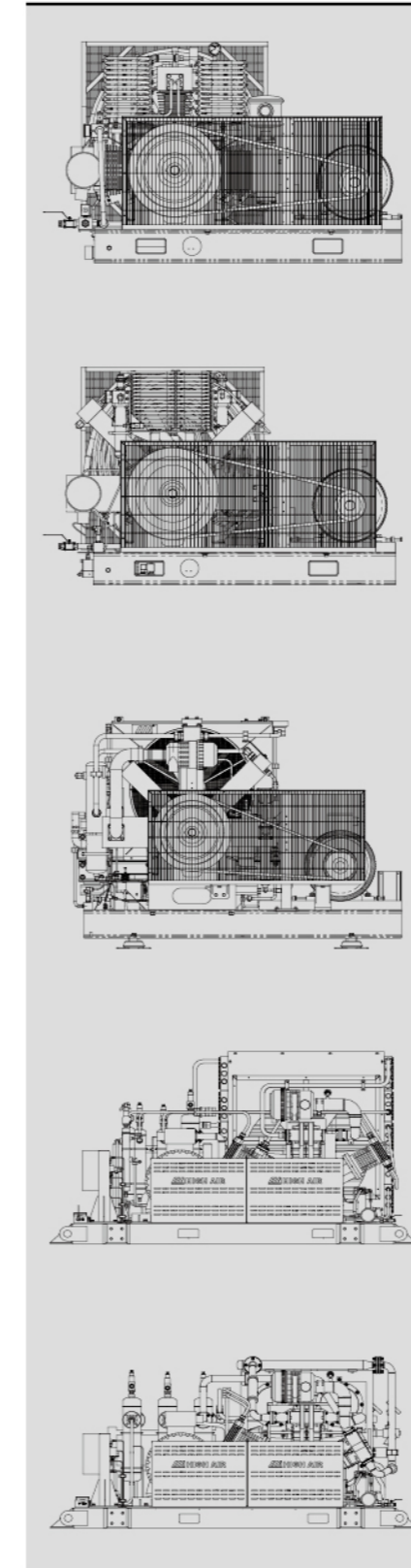

HG Series air compressor(Air cooling)

Model	Capacity M ³ /min	Maximum Working Pressure Bar	Stage	Cylinders	Motor Power KW	Dimension MM	Weight KG
HG 3-30	3.3	30	2	3	37	1800*950*1300	1000
HG 5-30	5.3	30	2	5	55	2300*1300*1500	1250
HG 8-30	8	30	3	6	90	3100*2000*1900	4500
HG 10-30	10	30	3	6	110	3100*2000*1900	4650
HG 3-50	3	50	3	4	45	2300*1300*1500	1350
HG 4-50	4.25	50	3	4	55	2300*1300*1500	1450
HG 8-50	8	50	3	6	110	3100*2000*1900	4650
HG 10-50	10	50	3	6	132	3100*2000*1900	4800
HG 1.5-80	1.5	80	3	3	22	1800*950*1300	900
HG 2-80	2	80	3	3	30	1800*950*1300	950
HG 2.5-80	2.5	80	3	3	37	1800*950*1300	1000
HG 3-100	3.5	100	4	5	55	2300*1300*1500	1500
HG 4.5-100	4.6	100	4	5	75	2300*1300*1500	1600
HG 8-100	8	100	4	6	132	3100*2000*1900	4800
HG 10-100	10	100	4	6	160	3100*2000*1900	5000
HG 1.5-150	1.5	150	4	4	30	1800*980*1250	1050
HG 2-150	2	150	4	4	37	1800*980*1250	1080
HG 3-150	3	150	4	5	55	2200*1200*1500	1450
HG 5-150	5	150	4	6	90	3100*2000*1900	4500
HG 8-150	8	150	4	6	132	3100*2000*1900	4800
HG 1.5-250	1.5	250	4	4	30	1800*980*1250	1050
HG 2-250	2	250	5	5	45	2300*1300*1500	1450
HG 3-250	3	250	4	5	55	2300*1300*1500	1500
HG 5-250	5	250	5	6	110	3100*2000*1900	4650
HG 8-250	8	250	5	6	160	3100*2000*1900	5000
HG 1.5-350	1.5	350	4	4	37	1800*980*1250	1080
HG 2-350	2	350	5	5	45	2300*1300*1500	1450
HG 2.5-350	2.5	350	5	5	55	2300*1300*1500	1500
HG 5-350	5	350	5	6	110	3100*2000*1900	4650
HG 8-350	8	350	5	6	160	3100*2000*1900	5000
HG 2.5-400	2.5	400	5	5	55	2300*1300*1500	1500
HG 6-400	6	400	5	6	132	3100*2000*1900	4800

-These standard specifications are for air cooling and belt driven units,if water cooling,please contact us

-For extra compressors 400/500bar,please contact us

-For other pressure or flow capacity,please contact us